

Data sheet | Item number: 733-106

1-conductor female plug; 100% protected against mismatching; 0.5 mm<sup>2</sup>; Pin spacing 2.5 mm; 6-pole

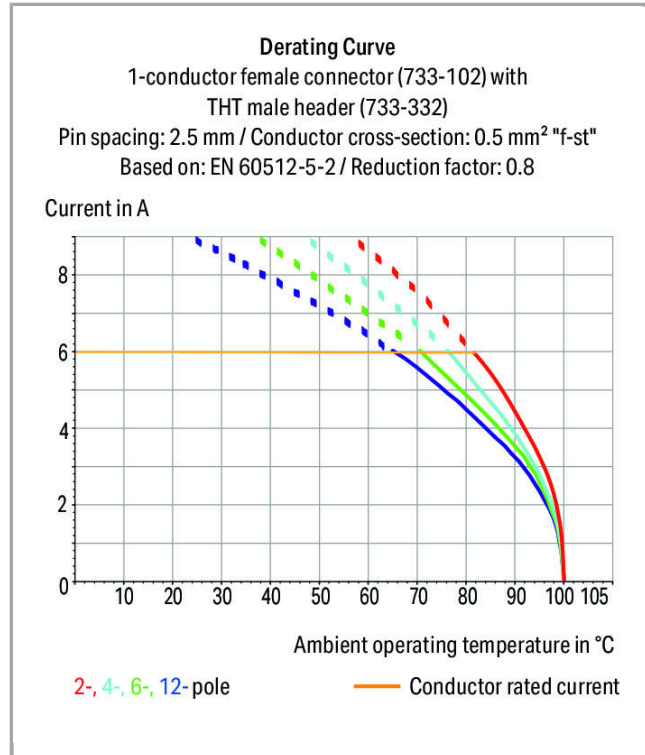

733-106



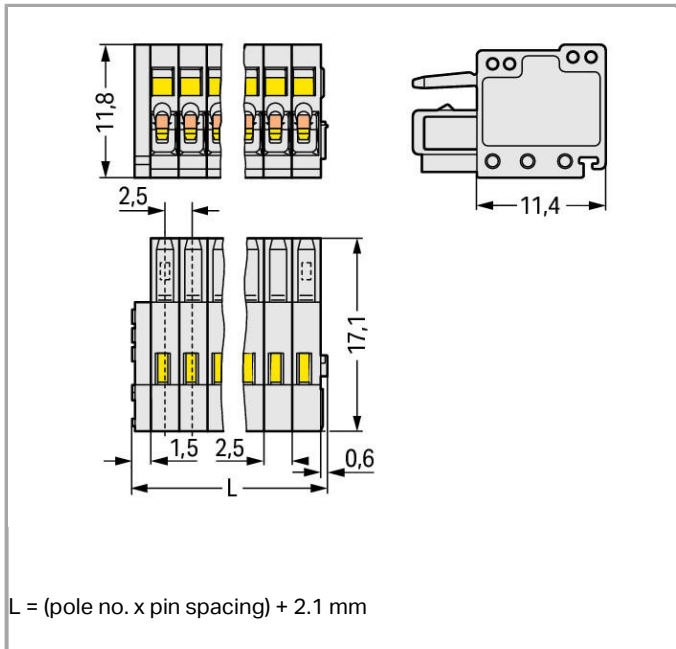

### Item description

- Universal connection for all conductor types
- Easy cable pre-assembly and on-unit wiring via vertical and horizontal CAGE CLAMP® actuation
- Strain relief plates for factory and in-the-field assembly
- 100% protected against mismatching
- Coding via coding fingers

### Safety information 1:

The *MULTI CONNECTION SYSTEM (MCS)* is designed without breaking capacity for compliance with DIN EN 61984. When used as intended, MCS Connectors shall not be connected/disconnected when live or under load. The circuit design should ensure header pins, which can be touched, are not live when unmated.

### Data

#### Electrical data

#### Ratings per IEC/EN 60664-1

Rated voltage (III / 3)	100 V
Rated impulse voltage (III / 3)	2.5 kV
Rated voltage (III / 2)	160 V
Rated impulse voltage (III / 2)	2.5 kV
Rated voltage (II / 2)	320 V
Rated impulse voltage (II / 2)	2.5 kV
Rated current	6 A

### Approvals per UL 1059

Rated voltage UL (Use Group B)	150 V
Rated current UL (Use Group B)	4 A

### Approvals per CSA

Rated voltage CSA (Use Group B)	150 V
Rated current CSA (Use Group B)	4 A

### Connection data

Connection technology	CAGE CLAMP®
Actuation type	Operating tool
Solid conductor	0.08 ... 0.5 mm <sup>2</sup> / 28 ... 20 AWG
Fine-stranded conductor	0.08 ... 0.5 mm <sup>2</sup> / 28 ... 20 AWG
Fine-stranded conductor with ferrule with plastic collar	0.25 ... 0.34 mm <sup>2</sup>
Fine-stranded conductor with ferrule without plastic collar	0.25 ... 0.34 mm <sup>2</sup>
Strip length	5 ... 6 mm / 0.2 ... 0.24 inch
No. of poles	6
Total number of connection points	6
Total number of potentials	6
Number of connection types	1
Number of levels	1
Conductor entry direction to mating direction	0°

### Geometrical Data

Pin spacing	2.5 mm / 0.098 inch
Width	17.1 mm / 0.673 inch
Height	11.8 mm / 0.465 inch
Depth	17.1 mm / 0.673 inch

### Plug connection

Contact type (pluggable connector)	Female connector/socket
Connector connection type	for conductors
Mismating protection	Yes

### Material Data

Color	light gray
Material group	I
Insulating material	Polyamide 66 (PA 66)

Flammability class per UL94	V0
Clamping spring material	Chrome nickel spring steel (CrNi)
Contact material	Copper alloy
Contact plating	tin-plated
Fire load	0.048 MJ
Weight	2.66 g

### Environmental Requirements



Limit temperature range	-60 ... +100 °C
-------------------------	-----------------

### Commercial data

Product Group	3 (Multi Conn. System)
Country of origin	DE
GTIN	4044918294058
Customs Tariff No.	85366990990

### Approvals / Certificates

#### Country specific Approvals



Logo	Approval	Additional Approval Text	Certificate name
	CCA DEKRA Certification B.V.	IEC 61984	NL-31141
	CCA DEKRA Certification B.V.	EN 61984	2169534.01
	CSA DEKRA Certification B.V.	C22.2	1465035
	CSA DEKRA Certification B.V.	C22.2	1465035

#### Ship Approvals

Logo	Approval	Additional Approval Text	Certificate name
	ABS American Bureau of Shipping	-	14- HG1241537- PDA
	DNV GL Det Norske Veritas, Germanischer Lloyd	-	TAE000016Z









## UL-Approvals

Logo	Approval	Additional Approval Text	Certificate name
	UL UL International Germany GmbH	UL 1977	E45171
	UL Underwriters Laboratories Inc.	UL 1059	20190122- E45172

## Compatible products

## tools

	<b>Item no.: 210-251</b> Operating tool; for female and male connectors with CAGE CLAMP® connection; MCS MINI & MICRO	210-251
	<b>Item no.: 210-719</b> Operating tool with partially insulated shaft; Type 1, blade (2.5 x 0.4) mm	210-719
	<b>Item no.: 233-331</b> Operating tool; for female and male connectors with CAGE CLAMP® connection; insulated	233-331
	<b>Item no.: 233-332</b> Operating tool; for 233 and 733 Series; of insulating material	233-332
	<b>Item no.: 233-335</b> Operating tool; for 233 and 733 Series	233-335
	<b>Item no.: 733-130</b> Operating tool; for male and female connectors with CAGE CLAMP®; loose	733-130
	<b>Item no.: 733-191</b> Operating tool; for male and female connectors with CAGE CLAMP®; loose	733-191

## check

	<b>Item no.: 735-500</b> Test pin; 1 mm Ø; with solder connection for test wire	735-500
--	--	---------

## Marking accessories

**Item no.: 210-331/250-202**  
Marking strips; as a DIN A4 sheet; MARKED; 1-16 (400x); Height of marker strip: 2.3 mm/0.091 in; Strip

length 182 mm; Horizontal marking; Self-adhesive

210-331

/ 250-202

**Item no.: 210-331/250-204**

Marking strips; as a DIN A4 sheet; MARKED; 17-32 (400x); Height of marker strip: 2.3 mm/0.091 in; Strip length 182 mm; Horizontal marking; Self-adhesive

210-331

/ 250-204

**Item no.: 210-331/250-206**

Marking strips; as a DIN A4 sheet; MARKED; 33-48 (400x); Height of marker strip: 2.3 mm/0.091 in; Strip length 182 mm; Horizontal marking; Self-adhesive

210-331

/ 250-206

**Item no.: 210-331/250-207**

Marking strips; as a DIN A4 sheet; MARKED; 1-48 (100x); Height of marker strip: 2.3 mm/0.091 in; Strip length 182 mm; Horizontal marking; Self-adhesive

210-331

/ 250-207

**Strain relief plate****Item no.: 734-128**

Strain relief plate; 12.5 mm wide

734-128

**ferrule****Item no.: 216-131**Ferrule; Sleeve for 0.25 mm<sup>2</sup> / AWG 24; uninsulated; electro-tin plated

216-131

**Item no.: 216-132**Ferrule; Sleeve for 0.34 mm<sup>2</sup> / AWG 24; uninsulated; electro-tin plated

216-132

**Item no.: 216-151**Ferrule; Sleeve for 0.25 mm<sup>2</sup> / AWG 24; uninsulated; electro-tin plated

216-151

**Item no.: 216-152**Ferrule; Sleeve for 0.34 mm<sup>2</sup> / AWG 24; uninsulated; electro-tin plated

216-152

**Item no.: 216-301**Ferrule; Sleeve for 0.25 mm<sup>2</sup> / AWG 24; insulated; electro-tin plated

216-301

**Item no.: 216-302**Ferrule; Sleeve for 0.34 mm<sup>2</sup> / 22 AWG; insulated; electro-tin plated

216-302

**Item no.: 216-321**Ferrule; Sleeve for 0.25 mm<sup>2</sup> / AWG 24; insulated; electro-tin plated

216-321

**Item no.: 216-322**Ferrule; Sleeve for 0.34 mm<sup>2</sup> / 22 AWG; insulated; electro-tin plated

216-322

**Downloads****CAD/CAE - Smart Data****CAD data**

3D Download 733-106

URL

Download



Subject to changes.

---